

DESCRIPTION: AC-DC Power Supply

SERIES: P1XE12GB

Features

- Output voltages from 3.3V to 24V
- 100-240Vac Universal AC input
- Energy efficiency level VI & CoC Tier2
- Protections: OVP OCP SCP
- Standard: IEC 62368
- Applications: Audio/Video, Information and Communication technology equipment



Certificates



Model

Order NO. **P1XE12** **GB** **- zzz** **yyyy**

1 **2** **3** **4**

1. Series number
2. Wall plug: MM=Interchangeable AC plug
 US=American fixed AC plug
 EU=European fixed AC plug
 BR=Brazilian fixed AC plug
 SA=African fixed AC plug
 IN=Indian fixed AC plug
 JP=Japanese fixed AC plug
 AU=Australian fixed AC plug
 CN=China fixed AC plug
 GB=United Kingdom fixed AC plug
 KR=Korean fixed AC plug
3. Output voltage: 033=3.3V, 240=24V
4. Output current: 0166=1.66A, 1500=15A

Model number	Power (W)	Output voltage (V)	Output current (A)
P1XE12GB-0330200	6.6	3.3	2.00
P1XE12GB-0500200	10	5.0	2.00
P1XE12GB-0600166	10	6.0	1.66
P1XE12GB-0750133	10	7.5	1.33
P1XE12GB-0900133	12	9.0	1.33
P1XE12GB-1200100	12	12.0	1.00
P1XE12GB-1500080	12	15.0	0.80
P1XE12GB-1800066	12	18.0	0.66
P1XE12GB-2400050	12	24.0	0.50

DESCRIPTION: **AC-DC Power Supply**

SERIES: **P1XE12GB**

Input

Characteristic	Minimum	Typical	Maximum	Units	Notes & Conditions
Input voltage	90	100-240	264	Vac	
Input frequency	47	50/60	63	Hz	
Input current			0.35	A	100Vac
No load power consumption			0.1	W	115/230Vac

Output

Characteristic	Minimum	Typical	Maximum	Units	Notes & Conditions
Voltage tolerance		±5.0		%	
Line regulation		±5.0		%	
Turn on delay			3	S	90Vac at full load
Ripple & Noise			200	mV	20MHz Bandwidth, 0.1µF & 10µF capacitor

Environmental

Characteristic	Minimum	Typical	Maximum	Units	Notes & Conditions
Operating temperature	0		40	°C	
Operating humidity	20		90	%	RH, non-condensing
Storage temperature	-10		60	°C	
Storage humidity	10		95	%	RH, non-condensing
MTBF	When the power supply is operating within the limits of this specification, the MTBF shall be at least 50000 hours at 25°C (MIL-HDBK-217F).				

Protections

Characteristic	Descriptions
Over current protection	105 ~ 150% rated output current. Protection type: Hiccup mode, which recovers automatically once the fault condition is removed.
Over voltage protection	Overvoltage protection must be included in the circuit to ensure that a single component failure does not cause an overvoltage.
Short circuit protection	The output can withstand a continuous short circuit without damage due to the hiccup mode protection feature, which automatically recovers once the fault condition is removed.

DESCRIPTION: AC-DC Power Supply

SERIES: P1XE12GB



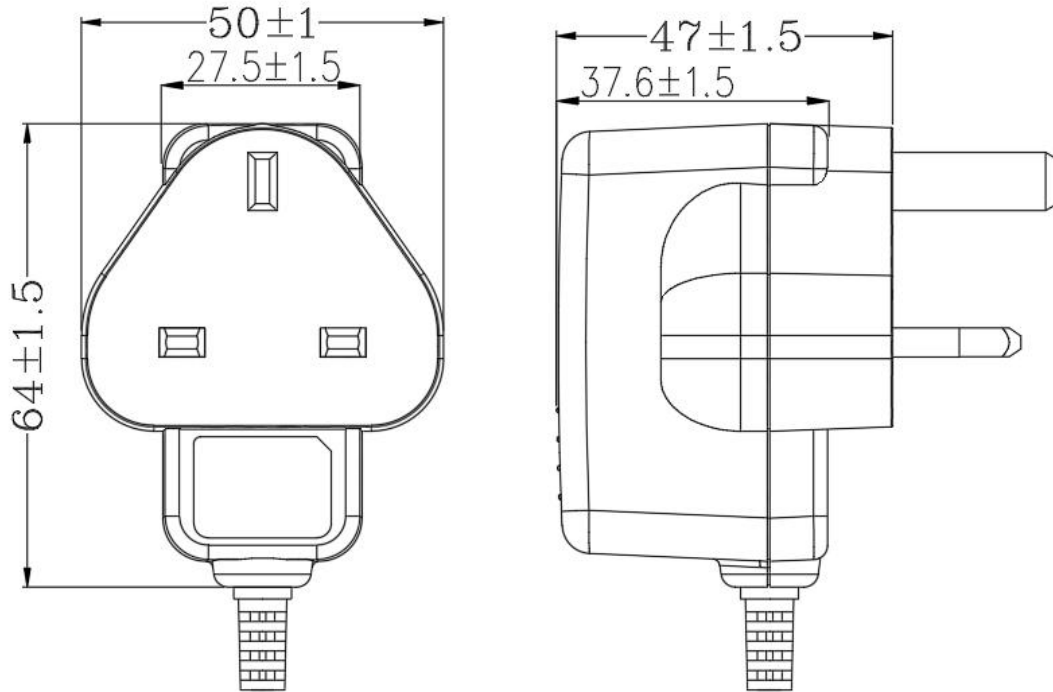







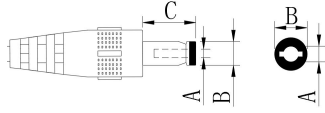

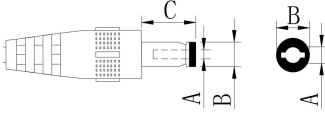

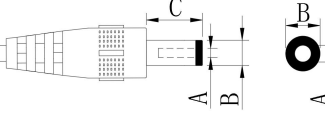

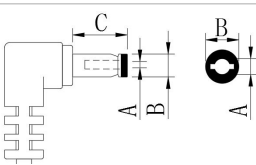
Mechanical

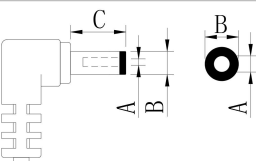

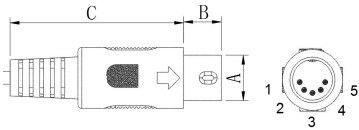
DESCRIPTION: **AC-DC Power Supply**

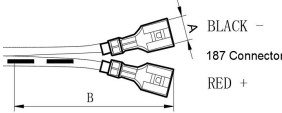
SERIES: **P1XE12GB**

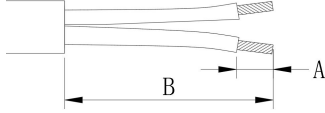
DC Plugs

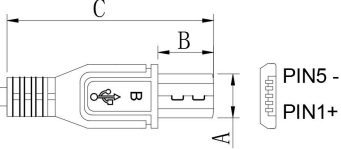
Serial No.	Outline		Notes
01 Tuning fork style (Standard plug)			A2.5*B5.5*C11mm 
02 Tuning fork style			A*B*C(mm) 2.5*5.5*8 2.5*5.5*9 2.5*5.5*9.5 2.5*5.5*10 2.5*5.5*11 2.5*5.5*12 2.5*5.5*13 2.5*5.5*14
03 Barrel style			
04 Tuning fork style			2.1*5.5*8 2.1*5.5*9 2.1*5.5*9.5 2.1*5.5*10 2.1*5.5*11 2.1*5.5*12 2.1*5.5*13 2.1*2.5*14
05 Barrel style			1.35*3.5*8.5 1.35*3.5*10 1.0*3.0*10 1.0*3.3*10
06 DIN 5 Pin (male)			A13*B8.0*C46mm PIN1 V- PIN5 V+
07 187 Connector			B50mm
08 Stripped and tinned leads			A5.0*B35mm
09 Micro-USB			
10 Type-C	